

## D10 Expert™ – Dual Discrete Outputs

Advanced sensor for use with plastic fiber optics

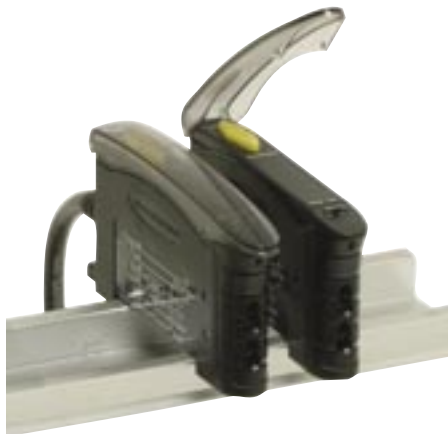

### Features

- Easy-to-set automatic *Expert*-style TEACH options\* including static, dynamic, and single-point programming plus manual adjustment for fine-tuning
- 16-bit microcontroller and 12-bit Analog-to-Digital converter for high-performance, low-contrast sensing
- Easy-to-read 4-digit display for TEACH and signal strength readout, plus indicators for a continuous readout of operating status (user configurable)
- Two discrete outputs, PNP or NPN
- Four-mode power and speed selection with automatic cross-talk avoidance circuitry
- Selectable OFF-delay options
- Gate input wire can be used to selectively inhibit sensor outputs from switching
- Models available with visible red (680 nm) or visible green (525 nm) sensing beam
- Models available with 2 m or 9 m (6.5' or 30') cable or integral Pico-style quick-disconnect
- Sleek, ultra-slim 10 mm housing, mounts to a standard 35 mm DIN rail

\* U.S. Patent #5,808,296

### Models

Models		Cables*	Discrete Outputs
Red Beam	Green Beam		
D10DNFP	D10DNFPG	2 m (6.5') Cable	NPN
D10DNFPQ	D10DNFPGQ	6-pin Pico-style QD	
D10DPFP	D10DPFPG	2 m (6.5') Cable	PNP
D10DPFPQ	D10DPFPGQ	6-pin Pico-style QD	

\* 9 m (30') cables are available by adding suffix "W/30" to the model number of any cabled sensor (e.g., D10DNFP W/30).  
A model with a QD connector requires a mating cable (see page 12).



#### WARNING . . . Not To Be Used for Personnel Protection

**Never use these products as sensing devices for personnel protection. Doing so could lead to serious injury or death.**

These sensors do NOT include the self-checking redundant circuitry necessary to allow their use in personnel safety applications. A sensor failure or malfunction can cause either an energized or de-energized sensor output condition. Consult your current Banner Safety Products catalog for safety products which meet OSHA, ANSI and IEC standards for personnel protection.

# D10 Expert™ Dual Discrete Outputs

## Overview

The D10 Expert Sensor is a high-performance plastic fiber-optic sensor whose many configuration (TEACH-mode) options make it suitable for demanding applications. Even with all its features, it is extremely easy to use. Advanced 16-bit microcontroller technology makes this possible.

The D10 Expert provides high-performance sensing in low-contrast applications. Expert TEACH and setup options provide static, dynamic and single-point programming plus manual fine adjustment, remote programming and push button lockout. Its slender, stylized housing has a large digital display visible beneath a clear cover for easy programming and status monitoring during operation. The sensor mounts directly to standard 35 mm DIN rail or using the supplied mounting bracket.

The sensor features two outputs with independent setpoints: either NPN or PNP, depending on model. Built-in crosstalk avoidance protocol provides trouble-free operation for multiple sensors in one area.

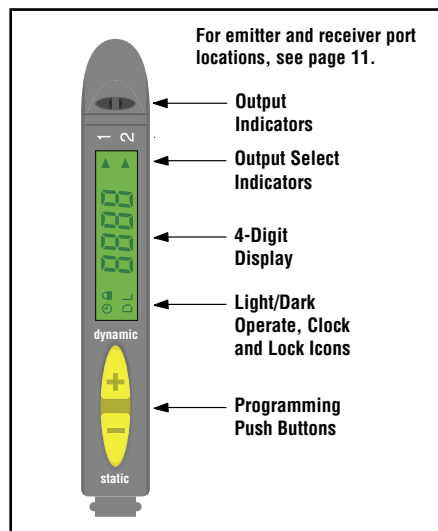

Figure 1. D10 features

## Programming Options

<b>Light/Dark Operate Selection</b>	Toggle to select the condition for which each output will conduct: when the target is present or when the target is absent.								
<b>OFF-Delay Timing Selection</b>	Programmable OFF-delay pulse stretcher: 0, 2, 5, 10, 15, 20, 30, 40, 60, 80, or 100 milliseconds								
<b>Display Selection</b>	<b>Discrete Output:</b> Raw signal value or % excess signal								
<b>Power Level/Speed Selection</b>	<b>Super High-Speed† (SHS)</b>		<b>High-Speed (HS)</b>		<b>High-Power (HP)</b>		<b>Super High-Power (SHP)</b>		
<b>Response*</b>	50 µs		200 µs		1 ms		2.5 ms		
<b>Repeatability</b>	25 µs		50 µs		75 µs		100 µs		
<b>Maximum Range*</b>	<b>Fiber</b>	<b>Red 680 nm</b>	<b>Green 525 nm</b>	<b>Red 680 nm</b>	<b>Green 525 nm</b>	<b>Red 680 nm</b>	<b>Green 525 nm</b>	<b>Red 680 nm</b>	<b>Green 525 nm</b>
	<b>PIT16U</b>	20 mm	9 mm	30 mm	9 mm	55 mm	13 mm	90 mm	16 mm
	<b>PIT26U</b>	100 mm	40 mm	150 mm	40 mm	250 mm	55 mm	400 mm	70 mm
	<b>PIT46U</b>	300 mm	100 mm	550 mm	100 mm	1000 mm	160 mm	1200 mm	180 mm
	<b>PIT66U</b>	600 mm	180 mm	1000 mm	180 mm	1700 mm	280 mm	2400 mm	320 mm
	<b>PBT16U</b>	6 mm	**	10 mm	**	18 mm	3 mm	30 mm	3.5 mm
	<b>PBT26U</b>	30 mm	12 mm	50 mm	12 mm	100 mm	20 mm	150 mm	25 mm
	<b>PBT46U</b>	100 mm	30 mm	175 mm	30 mm	250 mm	42 mm	300 mm	60 mm
<b>PBT66U</b>	175 mm	55 mm	250 mm	55 mm	400 mm	80 mm	475 mm	100 mm	
<b>Tracking Feature</b>	Sets Output 2 to identical settings as Output 1; Output 2 settings can then be revised as desired. (See Advanced Setup procedure, page 9.)								
<b>Factory Default Settings</b>	The following settings are preset at the factory; revert sensor to factory defaults using Advanced Setup procedure (page 9). <ul style="list-style-type: none"> <li>• Light operate (L)</li> <li>• Output 1 displayed</li> <li>• Maximum power setting</li> <li>• No OFF-delay (t 0)</li> <li>• High Speed (HS); 200 µs response</li> <li>• Discrete: switchpoint positioned at middle of range</li> <li>• Raw signal value (1234)</li> </ul>								

\* Diffuse mode performance based on 90% reflectance white test card.

\*\* ø0.010" bifurcated fiber not recommended in these speed settings. Contact Banner Applications for more information.

† See note on page 8.

## Sensor Programming

### Programming Procedures

Two push buttons, Dynamic (+) and Static (-), may be used to access and set programming parameters. For remote programming, connect a switch or digital input to the gray wire; length of the individual pulses is equal to the value T:

$$0.04 \text{ seconds} \leq T \leq 0.8 \text{ seconds}$$

### Returning to RUN mode

TEACH and SETUP modes each may be exited in one of two ways: by exercising the 60-second time-out, or by cancelling out of the process. In TEACH mode, the sensor will return to RUN mode without saving any of the new settings; in SETUP mode, the sensor will return to RUN mode but save all of the settings. To cancel out of TEACH mode, press and hold the Static (-) button for 2 seconds; to cancel out of SETUP mode, press and hold both the Static (-) and Dynamic (+) buttons for 2 seconds.

### Output 2

The setpoint(s) for each output can be set independently of one another (see Super-High-Speed Operation). However, the functional range available for output 2 is dictated by the automatic power and gain settings established for output 1. Whenever output 1 is taught, output 2 also must be retaught. Applications hint: teach the weakest signal on output 1 first.

### Dynamic TEACH and Adaptive Thresholds



Dynamic TEACH is used to program sensitivity during actual machine run conditions. During Dynamic TEACH, the sensor takes multiple samples of the light and dark conditions and automatically sets the sensitivity at the optimum level. Dynamic TEACH activates the sensor's adaptive threshold system, which continuously tracks minimum and maximum signal levels, and automatically maintains centering of the switch point between the light and dark conditions. The adaptive threshold system remains in effect during RUN mode to automatically adjust for changes in the light or the dark conditions.

When Dynamic TEACH mode is used to program sensitivity, the output ON state (light or dark operate) will remain as it was last programmed. To change to either light or dark operate, use the SETUP mode (see page 7).

Sensitivity may be adjusted at any time when the sensor is in RUN mode by clicking the "+" and "-" buttons. However, when a manual adjustment is made, the adaptive threshold system is disabled (cancelled).

## Active Channel Select



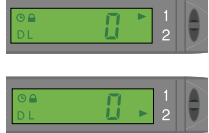





- Selects which channel to teach
- Displays channel configuration information.

Active Channel Select	Push Button	Remote 0.04 sec. ≤ T ≤ 0.8 sec.	Result
	<ul style="list-style-type: none"> <li>• Single-click both buttons simultaneously.</li> </ul> 	<ul style="list-style-type: none"> <li>• Triple-pulse the remote line.</li> </ul> 	<p><b>Pointer icon:</b> moves to the other channel indicator.</p> 

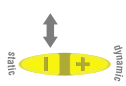
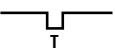
# D10 Expert™ Dual Discrete Outputs

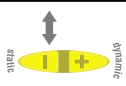
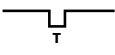
## Static TEACH







- Two-point TEACH to set a single threshold.
- Threshold is adjustable using the “+” and “-” buttons (see Manual Adjust, page 6).

	Push Button	Remote 0.04 sec. ≤ T ≤ 0.8 sec.	Result										
Access Static TEACH Mode	<ul style="list-style-type: none"> <li>• Press and hold Static (-) button.</li> </ul> 	<ul style="list-style-type: none"> <li>• No action required; sensor is automatically ready for 1st TEACH condition.</li> </ul>	<ul style="list-style-type: none"> <li>• Display flashes “1st”</li> <li>• Arrow icon turns red</li> </ul> 										
Teach Output ON Condition	<ul style="list-style-type: none"> <li>• Present Output ON target.</li> <li>• Click Static button.</li> </ul> 	<ul style="list-style-type: none"> <li>• Present Output ON target.</li> <li>• Single-pulse the remote line.</li> </ul> 	<ul style="list-style-type: none"> <li>• Display flashes “2nd”</li> </ul> 										
Teach Output OFF Condition	<ul style="list-style-type: none"> <li>• Present Output OFF target.</li> <li>• Click Static button.</li> </ul> 	<ul style="list-style-type: none"> <li>• Present Output OFF target.</li> <li>• Single-pulse the remote line.</li> </ul> 	<p><b>TEACH conditions acceptable:</b></p> <ul style="list-style-type: none"> <li>• Display flashes “pass,” followed by a number (denoting contrast); see table below.</li> </ul> <table border="1" data-bbox="917 966 1177 1155"> <thead> <tr> <th colspan="2">Contrast Values</th> </tr> </thead> <tbody> <tr> <td>500+</td> <td>Excellent</td> </tr> <tr> <td>100 - 500</td> <td>Good</td> </tr> <tr> <td>32 - 99</td> <td>Low</td> </tr> <tr> <td>0 - 31</td> <td>Marginal</td> </tr> </tbody> </table> <ul style="list-style-type: none"> <li>• Sensor returns to RUN mode with new settings.</li> <li>• Arrow icon turns green</li> </ul> <p><b>TEACH conditions unacceptable:</b></p> <ul style="list-style-type: none"> <li>• Display flashes “fail” and returns to “1st”</li> <li>• Arrow icon remains red</li> <li>• After 60 seconds, sensor returns to RUN mode (Arrow icon turns green) without changing settings.</li> </ul>   	Contrast Values		500+	Excellent	100 - 500	Good	32 - 99	Low	0 - 31	Marginal
Contrast Values													
500+	Excellent												
100 - 500	Good												
32 - 99	Low												
0 - 31	Marginal												

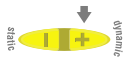
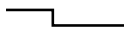
# D10 Expert™ Dual Discrete Outputs

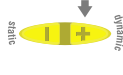
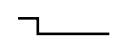
## Dynamic TEACH

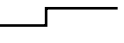







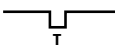

- TEACH on-the-fly.
- Sets a single threshold.
- Threshold is adjustable using the “+” and “-” buttons (see Manual Adjust, page 6).

	Push Button	Remote	Result										
<b>Access Dynamic TEACH Mode</b>	<ul style="list-style-type: none"> <li>• Press and hold Dynamic (+) button.</li> </ul> 	<ul style="list-style-type: none"> <li>• Hold remote line low (to ground).</li> </ul> 	<ul style="list-style-type: none"> <li>• Display flashes “dyn”</li> <li>• Arrow icon turns red</li> </ul> 										
<b>Teach Sensing Conditions</b>	<ul style="list-style-type: none"> <li>• Present Output ON/OFF conditions while continuing to hold Dynamic button.</li> </ul> 	<ul style="list-style-type: none"> <li>• Present Output ON/OFF conditions while continuing to hold remote line low (to ground)</li> </ul> 											
<b>Return to RUN Mode</b>	<ul style="list-style-type: none"> <li>• Release Dynamic button.</li> </ul> 	<ul style="list-style-type: none"> <li>• Release remote line/switch.</li> </ul> 	<p><b>TEACH conditions acceptable:</b></p> <ul style="list-style-type: none"> <li>• Display flashes “pass,” followed by a number (denoting contrast); see table below.</li> </ul> <table border="1" data-bbox="958 1029 1218 1218"> <thead> <tr> <th colspan="2">Contrast Values</th> </tr> </thead> <tbody> <tr> <td>500+</td> <td>Excellent</td> </tr> <tr> <td>100 - 500</td> <td>Good</td> </tr> <tr> <td>32 - 99</td> <td>Low</td> </tr> <tr> <td>0 - 31</td> <td>Marginal</td> </tr> </tbody> </table> <ul style="list-style-type: none"> <li>• Sensor returns to RUN mode with new settings.</li> <li>• Arrow icon turns green</li> </ul>  <p><b>TEACH conditions unacceptable:</b></p> <ul style="list-style-type: none"> <li>• Display flashes “fail”</li> <li>• Arrow icon remains red</li> <li>• Sensor returns to RUN mode (Arrow icon turns green) without changing settings.</li> </ul> 	Contrast Values		500+	Excellent	100 - 500	Good	32 - 99	Low	0 - 31	Marginal
Contrast Values													
500+	Excellent												
100 - 500	Good												
32 - 99	Low												
0 - 31	Marginal												

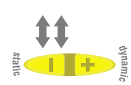
# D10 Expert™ Dual Discrete Outputs





## Single-Point Static TEACH

- Used to set a single ON condition.
- All other conditions (both lighter and darker) will result in an OFF output.
- Target ON condition sensitivity is adjustable using the “+” and “-” buttons (see Manual Adjust, below).

	Push Button	Remote 0.04 sec. ≤ T ≤ 0.8 sec.	Result
Access TEACH Mode	<ul style="list-style-type: none"> <li>• Press and hold Static (-) button.</li> </ul> 		<ul style="list-style-type: none"> <li>• Display flashes “1st”</li> <li>• Arrow icon turns red</li> </ul> 
		<ul style="list-style-type: none"> <li>• Present target to learn.</li> <li>• Single-pulse the remote line.</li> </ul> 	<ul style="list-style-type: none"> <li>• Display flashes “2nd”</li> <li>• Arrow icon turns red</li> </ul> 
Teach Setpoint (Output ON) Condition	<ul style="list-style-type: none"> <li>• Present target to learn.</li> <li>• Double-click the Static button.</li> </ul> 	<ul style="list-style-type: none"> <li>• Double-pulse the remote line.</li> </ul> 	<p><b>TEACH conditions acceptable:</b></p> <ul style="list-style-type: none"> <li>• Display flashes “snGL,” then “pt” twice</li> <li>• Sensor returns to RUN mode with new settings.</li> <li>• Arrow icon turns green</li> </ul>   <p><b>TEACH conditions unacceptable:</b></p> <ul style="list-style-type: none"> <li>• Display flashes “fail” and returns to “1st”</li> <li>• Arrow icon remains red</li> <li>• After 60 seconds, sensor returns to RUN mode (Arrow icon turns green) without changing settings.</li> </ul>  

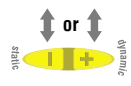
## Manual Adjust



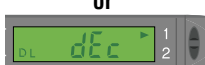







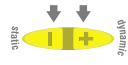





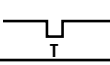



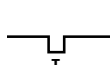

- May be used at any time sensor is in RUN mode.
- Fine-tunes the sensing thresholds or adjusts sensitivity to the single-point target conditions.

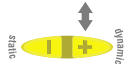
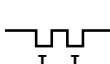
	Push Button	Remote	Result
Manual Adjust	<ul style="list-style-type: none"> <li>• Click “+” to increase, or click “-” to decrease.</li> </ul> 	<ul style="list-style-type: none"> <li>• Not available with remote programming.</li> </ul>	<ul style="list-style-type: none"> <li>• Display briefly flashes the threshold setpoint value as it is being changed.</li> </ul>   <p>or</p> <ul style="list-style-type: none"> <li>• Display flashes “inc” or “dec” as single-point tolerance is adjusted.</li> </ul>  

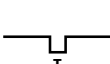
# D10 Expert™ Dual Discrete Outputs

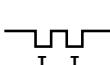
## Sensor Setup

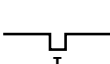
- Configures sensor display and operating parameters.
- Changes are updated instantly.
- Click Dynamic (+) or double-pulse remote line to select an option.
- Click Static (-) or single-pulse remote line to advance.

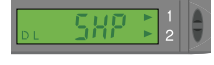

	Push Button	Remote 0.04 sec. ≤ T ≤ 0.8 sec.	Result
<b>Access SETUP Mode</b>	<ul style="list-style-type: none"> <li>• Press and hold both buttons concurrently.</li> </ul> 	<ul style="list-style-type: none"> <li>• Double-pulse the remote line.</li> </ul> 	<ul style="list-style-type: none"> <li>• Arrow icon turns red</li> </ul>
<b>Select Light/Dark Operate</b>	<ul style="list-style-type: none"> <li>• Click Dynamic to toggle between selections.</li> </ul> 	<ul style="list-style-type: none"> <li>• Double-pulse remote line to toggle between selections.</li> </ul> 	<b>Light Operate:</b> <ul style="list-style-type: none"> <li>• Display flashes "lo"</li> <li>• L icon</li> </ul> 
	<ul style="list-style-type: none"> <li>• Click Static to save selection and advance to "OFF-Delay."</li> </ul> 	<ul style="list-style-type: none"> <li>• Single-pulse the remote line to save selection and advance to "OFF-Delay."</li> </ul> 	<b>Dark Operate:</b> <ul style="list-style-type: none"> <li>• Display flashes "do"</li> <li>• D icon</li> </ul> 
<b>Select OFF-Delay Timing Enable</b>	<ul style="list-style-type: none"> <li>• Click Dynamic to toggle between selections.</li> </ul> 	<ul style="list-style-type: none"> <li>• Double-pulse the remote line to toggle between selections.</li> </ul> 	<b>OFF (No OFF-Delay):</b> <ul style="list-style-type: none"> <li>• "t 0"</li> <li>• Clock icon OFF</li> </ul> 
	<ul style="list-style-type: none"> <li>• Click Static to save selection and advance to "Display."</li> </ul> 	<ul style="list-style-type: none"> <li>• Single-pulse the remote line to save selection and advance to "Display."</li> </ul> 	<b>2 to 100 ms OFF-Delay:</b> <ul style="list-style-type: none"> <li>• "t 2," "t 5," "t 10," "t 15," "t 20," "t 30," "t 40," "t 60," "t 80," or "t 100"</li> <li>• Clock icon ON</li> </ul> 
<b>Select Display Parameters</b>	<ul style="list-style-type: none"> <li>• Click Dynamic (+) to toggle between selections.</li> </ul> 	<ul style="list-style-type: none"> <li>• Double-pulse the remote line to toggle between selections.</li> </ul> 	<b>Raw signal value:</b> <ul style="list-style-type: none"> <li>• 1234</li> </ul> 
	<ul style="list-style-type: none"> <li>• Click Static (-) to save selection and advance to "Power/Speed."</li> </ul> 	<ul style="list-style-type: none"> <li>• Single-pulse the remote line to save selection and advance to "Power/Speed."</li> </ul> 	<b>Percent of excess signal:</b> <ul style="list-style-type: none"> <li>• 123P</li> </ul> 
<b>Select Power and Speed Combination</b>	<ul style="list-style-type: none"> <li>• Click Dynamic (+) to toggle between selections.</li> </ul> 	<ul style="list-style-type: none"> <li>• Double-pulse the remote line to toggle between selections.</li> </ul> 	<b>Super-high-speed (50-µs response)</b> <ul style="list-style-type: none"> <li>• SHS (Complementary outputs; see note below)</li> </ul> 
	<ul style="list-style-type: none"> <li>• Click Static (-) to save selection and return to RUN mode.</li> </ul> 	<ul style="list-style-type: none"> <li>• Single-pulse the remote line to save selection and return to RUN mode.</li> </ul> 	<b>High-speed (200-µs response)</b> <ul style="list-style-type: none"> <li>• HS</li> </ul> 
			<b>High-power (1-ms response)</b> <ul style="list-style-type: none"> <li>• HP</li> </ul> 
			<b>Super-high-power (2.5-ms response)</b> <ul style="list-style-type: none"> <li>• SHP</li> </ul> 

**Super-High-Speed Operation Note:** Under most conditions, the sensor's two discrete outputs operate independently. However, the outputs become complementary when operating at Super-High-Speed, due to its extremely fast response time. Only channel 1 is taught/adjusted; channel 2 is complementary to it (output 1 conducts for the taught ON condition, and output 2 conducts for the OFF state). To invert these conditions (output 1 – OFF condition, output 2 – ON), change light/dark operate setting.

# D10 Expert™ Dual Discrete Outputs

## Push Button Lockout

- Prevents unwanted adjustments or tampering of the push buttons.
- Push buttons can be enabled or disabled only from the remote line and only during normal RUN mode.

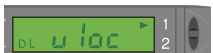









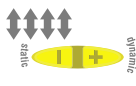
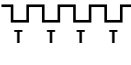

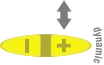



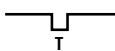

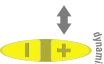
	Push Button	Remote 0.04 sec. ≤ T ≤ 0.8 sec.	Result
Enable or Disable Push Buttons	<ul style="list-style-type: none"> <li>• Not available with push-button programming.</li> </ul>	<ul style="list-style-type: none"> <li>• From RUN mode, quad-pulse the remote line to toggle between selections.</li> </ul> 	<p><b>Push Buttons Disabled:</b></p> <ul style="list-style-type: none"> <li>• Display flashes "loc"</li> <li>• Padlock icon appears</li> <li>• Sensor remains in RUN mode</li> </ul>  <p><b>Push Buttons Enabled:</b></p> <ul style="list-style-type: none"> <li>• Display flashes "uloc"</li> <li>• Padlock icon disappears</li> <li>• Sensor remains in RUN mode</li> </ul> 

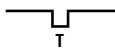

# D10 Expert™ Dual Discrete Outputs

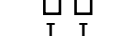
## Advanced Setup

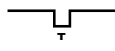
- Advanced adjustments to previously configured sensor display and operating parameters.
- Quad-click Static (-) or quad-pulse remote line before exiting “Power and Speed” settings to enter this mode.
- Click Dynamic (+) or double-pulse remote line to select an option.
- Click Static or single-pulse remote line to advance.
- Changes are updated instantly.

	Push Button	Remote 0.04 sec. ≤ T ≤ 0.8 sec.	Result
<b>Enter SETUP Mode</b>	<ul style="list-style-type: none"> <li>• From “Power and Speed” mode, quad-click Static (-) button.</li> </ul> 	<ul style="list-style-type: none"> <li>• From “Power and Speed” mode, quad-click the remote line.</li> </ul> 	<ul style="list-style-type: none"> <li>• Arrow icon remains red</li> <li>• Display shows “Tracking Enabled” option.</li> </ul> 
<b>Track Enable</b>	<ul style="list-style-type: none"> <li>• Click Dynamic (+) to toggle between selections.</li> </ul> 	<ul style="list-style-type: none"> <li>• Double-pulse the remote line to toggle between selections.</li> </ul> 	<p><b>Sets output 2 identical to output 1</b></p> <p><b>Tracking disabled:</b></p> <ul style="list-style-type: none"> <li>• Display shows “tr n”</li> </ul> 
	<ul style="list-style-type: none"> <li>• Click Static (-) to save selection and advance to “Factory Default.”</li> </ul> 	<ul style="list-style-type: none"> <li>• Single-pulse the remote line to save selection and advance to “Factory Default.”</li> </ul> 	<p><b>Tracking enabled:</b></p> <ul style="list-style-type: none"> <li>• Display shows “tr y”</li> </ul> 
<b>Factory Default Settings</b>	<ul style="list-style-type: none"> <li>• Click Dynamic (+) to toggle between selections.</li> </ul> 	<ul style="list-style-type: none"> <li>• Double-pulse the remote line to toggle between selections.</li> </ul> 	<p><b>Returns to factory default factory settings</b></p> <p><b>Factory Default Settings Not Selected:</b></p> <ul style="list-style-type: none"> <li>• Display shows “fd n”</li> </ul> 
	<ul style="list-style-type: none"> <li>• Click Static (-) to advance to “Display Orientation.”</li> </ul> 	<ul style="list-style-type: none"> <li>• Single-pulse the remote line to advance to “Display Orientation.”</li> </ul> 	<p><b>Factory Default Settings Selected:</b></p> <ul style="list-style-type: none"> <li>• Display shows “fd y”</li> </ul> 
<b>Display Orientation</b>	<ul style="list-style-type: none"> <li>• Click Dynamic (+) to toggle between selections.</li> </ul> 	<ul style="list-style-type: none"> <li>• Double-pulse the remote line to toggle between selections.</li> </ul> 	<p><b>Inverts display to read “upside-down”</b></p> <p><b>Normal:</b></p> <ul style="list-style-type: none"> <li>• For example: 1234</li> </ul> 
	<ul style="list-style-type: none"> <li>• Click Static (-) to return to RUN mode.</li> </ul> 	<ul style="list-style-type: none"> <li>• Single-pulse the remote line to return to RUN mode.</li> </ul> 	<p><b>Inverted:</b></p> <ul style="list-style-type: none"> <li>• For example: 4E21</li> <li>NOTE: Icons do not invert.</li> </ul> 

# D10 Expert™ Dual Discrete Outputs

## Self-Diagnostic Error Modes

In the unlikely event that the setup parameters are lost or become corrupt, the display will continuously scroll: "USEr PSF Error." Reteach the sensor to recover. If the problem persists, contact your Banner representative for further information.

## Gate Input

The pink wire is configured as a gate input. When this wire is pulled low (i.e., to the sensor ground), it inhibits the outputs from switching, while all other sensor functions continue to be enabled. This feature is useful for controlling when the outputs are allowed to change states. Gate input function response time is 1 millisecond.

## Specifications

<b>Required Fiber-Optic Cable</b>	Banner P-Series plastic fibers		
<b>Sensing Beam</b>	Visible red, 680 nm, or Visible green, 525 nm, depending on model		
<b>Supply Voltage and Current</b>	12 to 24V dc (10% maximum ripple) at less than 65 mA, exclusive of load		
<b>Supply Protection Circuitry</b>	Protected against reverse polarity and transient voltage		
<b>Output Configuration</b>	2 NPN or 2 PNP, depending on model		
<b>Output Rating</b>	150 mA maximum load <b>OFF-state leakage current:</b> < 10 µA at 24V dc <b>ON-state saturation voltage:</b> NPN < 1.5V at 150 mA load PNP < 2.5V at 150 mA load		
<b>Output Protection Circuitry</b>	Protected against false pulse on power-up and continuous short-circuit		
<b>Output Response Time</b>	Programmable, 50 microseconds, 200 microseconds, 1 millisecond, 2.5 milliseconds NOTE: < 1 second delay on power-up; outputs do not conduct during this time.		
<b>Adjustments</b>	Push-button or remote programming of response time, OFF-delay, light/dark operate, and display		
<b>Indicators</b>	Four-digit digital display plus LED indicators for active channel, push-button lockout, OFF-delay and light/dark operate selection; 2 yellow output indicators		
<b>Construction</b>	Black ABS/polycarbonate alloy (UL94 V-0 rated) housing, clear polycarbonate cover		
<b>Environmental Rating</b>	NEMA 1, IEC IP50		
<b>Connections</b>	PVC-jacketed 2 m or 9 m (6.5' or 30') 6-wire integral cable or integral 6-pin Pico-style quick-disconnect		
<b>Operating Conditions</b>	<b>Temperature:</b> -20° to +55°C (-4° to +131°F) <b>Storage Temperature:</b> -20° to +80°C (-4° to +175°F) <b>Max. Rel. Humidity:</b> 90% @ 50°C (non-condensing)		
	<b>Number of Devices, Stacked</b>	<b>Ambient Temperature Rating</b>	<b>Load Specification</b>
	3	55°C	150 mA
	7	50°C	50 mA
10	45°C	50 mA	
<b>Installation</b>	35 mm DIN rail or included mounting bracket		
<b>Certifications</b>			

# D10 Expert™ Dual Discrete Outputs

## Dimensions

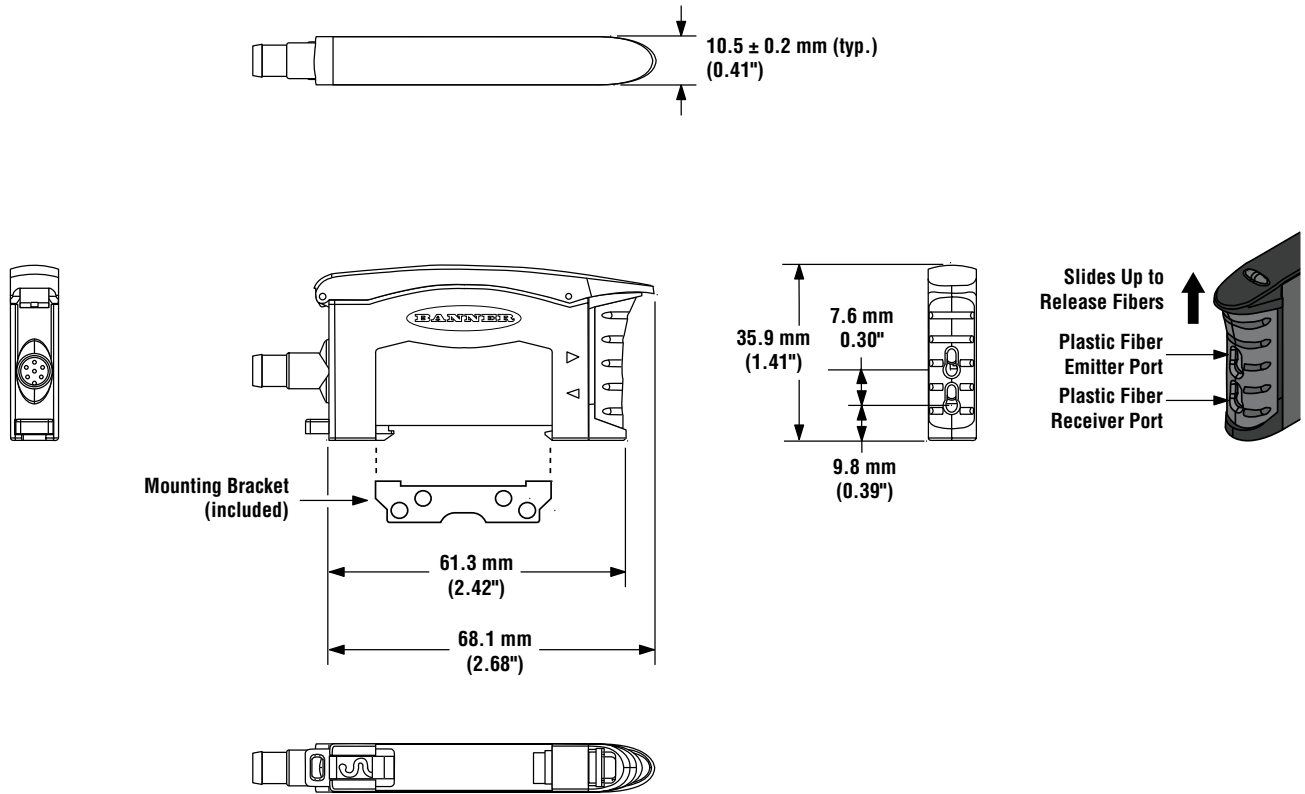

### Included Bracket Dimensions

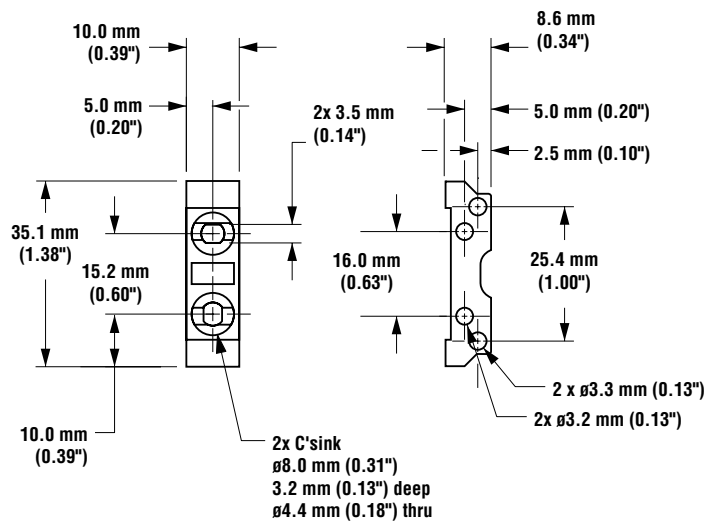

M3 Hardware included:  
 Lock Washer (2)  
 Flat Washer (2)  
 Screws (2)  
 Hex Nuts (2)

# D10 Expert™ Dual Discrete Outputs

## Hookups

### NPN Output Models

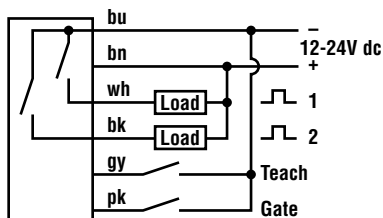

### PNP Output Models

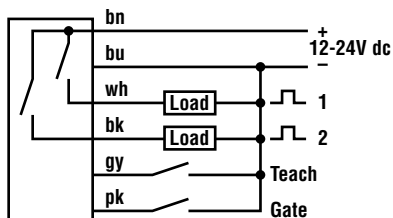

NOTE: QD hookups are functionally identical.

## Accessories

### Pico-Style Quick-Disconnect Cables

**Cable:** PUR jacket, polyurethane connector body, POM snap-lock coupling

**Conductors:** 26 or 24 AWG high-flex stranded, gold-plated contacts

**Temperature:** -40° to +90°C (-40° to +194°F)

**Voltage Rating:** 30V ac/36V dc

Style	Model	Length	Dimensions	Pin-out
6-Pin Straight	PKG6Z-2	2 m (6.5')		
	PKG6Z-9	9 m (30')		
6-Pin Right-angle	PKW6Z-2	2 m (6.5')		
	PKW6Z-9	9 m (30')		



**WARRANTY:** Banner Engineering Corp. warrants its products to be free from defects for one year. Banner Engineering Corp. will repair or replace, free of charge, any product of its manufacture found to be defective at the time it is returned to the factory during the warranty period. This warranty does not cover damage or liability for the improper application of Banner products. This warranty is in lieu of any other warranty either expressed or implied.